

## **Agenda 23-18**

Regular Meeting of the Council of the Village of Carmacks, Yukon to be held in the Council Chambers of the Carmacks Municipal Building at 7:00 PM on Tuesday, September 19, 2023.

### **1. CALL TO ORDER**

### **2. AGENDA**

(motion to adopt)

### **3. ADOPTION OF MINUTES**

(motion to adopt)

3.1 Regular meeting of September 5, 2023

### **4. DELEGATION**

4.1 Rezoning Public Hearing – Lot #1092 – Public Forum

### **5. CORRESPONDENCE**

5.1 CIMCO Toromont Customer Support Agreement

5.2 Yukon Quest – Letter of Support

### **6. REPORTS**

6.1 Council Activity Reports

6.2 Mayor Report

6.3 CAO Report

6.4 AYC

### **7. ACCOUNTS PAID AND PAYABLES**

### **8. BYLAWS**

(motion to adopt)

### **9. NEW & UNFINISHED BUSINESS**

9.1 Yukon Housing Corp – Board Meeting October 26<sup>th</sup>

9.2 Carmacks Sanitary Sewer Repairs – Review Attachment

### **10. QUESTION PERIOD**

### **11. INCAMERA**

(motion to go in and out of session and recorded time)

### **12. ADJOURNMENT**

**MINUTES FROM THE REGULAR MEETING OF THE COUNCIL FOR THE VILLAGE OF CARMACKS ON SEPTEMBER 5<sup>TH</sup> , 2023 IN THE MUNICIPAL COUNCIL CHAMBERS**

**PRESENT:** Mayor: Lee Bodie

Councillors: J. Lachance, D. Hansen, K. Unterschute, H. Belanger

Staff: CAO M. Cybulski, A. Wylimczyk

Delegation: RCMP Cpl. D. MacNeil, LSCFN & Yukon Bright

E. Fairclough, J. McGillivray, PWGM Brian King, Rec-Director

M. Wittkopf

**ORDER:** Mayor L. Bodie called the meeting to order at 7:00 PM.

**AGENDA:** Council reviewed the agenda.

**23-17-01 M/S Councillors J. Lachance/ D. Hansen motioned that the agenda be accepted as presented.**

**CARRIED**

**MINUTES:** From the regular meeting on August 15, 2023.

**23-17-02 M/S Councillors J. Lachance/ D. Hansen motioned that the minutes be accepted as presented.**

**CARRIED**

**DELEGATION:**

4.1. RCMP Cpl. MacNeil provided written report and broke it down verbally. July was a busy month compared to last year. RCMP detachment members did a few traffic stops where tickets had been given to drivers because of missing and or insurance or registrations. August was a bit slower. They received less calls. RCMP were called out to a mining company at Mt. Nansen about an incident where one of the mining crew members had passed away.

4.2. J. McGillivray and E. Fairclough presented a slide show of the future Heritage building to council during the public hearing. LSCFN has applied for a rezoning amendment.

## **CORRESPONDENCE:**

### **5.1. BDO Slideshow – Asset Retirement Obligations**

CAO M. Cybulski provided the information to council and told them that he and PW GM B. King are going to attend the Asset Management course for the next couple months.

### **5.2. Letter from B. Cooper**

Mayor Bodie read letter to council that she won't be renewing her contract as of October 1<sup>st</sup>, 2023. Council thanked her for her services for more than a decade and wished her all the best.

5.3. Mayor Bodie read the Youth Award 2023 recognition for Steven Domingo. He is very proud of him and wished him all the best in the near future.

## **REPORTS:**

### **Councillor Activity Reports**

Councillor D. Hansen attended the first Landfill meeting and is excited to attend the AYC Board meeting on September 8<sup>th</sup> and 9<sup>th</sup> here in Carmacks.

Councillor J. Lachance attended the Landfill and Rec-Board meeting.

Councillor K. Unterschute has nothing to report. He was busy at work.

Councillor H. Belanger has nothing to report. She was out of town for business.

### **Mayor's Report**

Mayor Bodie was disappointed that only 5 community members attended the Landfill meeting on September 16<sup>th</sup>. He apologized for missing the meeting with the Crusader Church Minister on Friday. Mayor Bodie was invited from CDC to tour through some streets of Carmacks, the gravel pit and new houses that they have built. He is excited to host the BBQ for AYC Board members Friday night.

### **CAO Report**

CAO M. Cybulski presented Council with a written report and broke it down verbally.

The Firehall Grand opening will be on September 16<sup>th</sup>. A costs analysis has been completed.

A few development permits have been approved. He updated a number of permit applications which will be available online coming October.

CAO M. Cybulski is looking forward to a Landfill walkthrough with YG that was postponed for a number of reasons.

Premier Ranj Pillai will be visiting Carmacks on October 17<sup>th</sup>, 2023.

### **Recreation Centre Report**

New Rec-Director Meesha Wittkopf introduced herself to council and broke down written report verbally. She informed council about the variety of programming that are provided to school kids and youth.

The Rugged Apprenticeship days will be happening from September 14-16. The Klondike Culture Days will follow a week after. A lot of events have been planned and she hopes that everything goes smoothly.

### **Finance Report**

Finance officer A. Wylimczyk provided written report to council and broke it down verbally. We are in the final stages of the audit and needed to request an extension until the end of September.

### **Municipal Maintenance Report**

PW General Manager Brian King introduced himself to council and provided an update on PW report. He said that the PW department is doing well. He works on the Gas Tax funding to update the PW vehicle fleet and looks into different options.

### **Fire Department Report**

Council read the report provided.

### **AYC Report**

Councillor D. Hansen is looking forward to the Director's meeting on Friday and the Board meeting on Saturday.

### **ACCOUNTS PAID AND PAYABLES**

No report provided.

### **BYLAWS**

#### **8.1. Bylaw 292-23 Municipal Officer – Signing Authority Bylaw**

- 23-17-03 MS Councillors H. Belanger/ K. Unterschute motioned to give Bylaw 292-23 Municipal Officer – Signing Authority Bylaw 3<sup>rd</sup> and final reading.**
- CARRIED**

**8.2. Bylaw 293-23 Carmacks Zoning Amendment Bylaw**

- 23-17-04 MS Councillors D. Hansen/ H. Belanger motioned to give Bylaw 293-23 – Carmacks Zoning Amendment Bylaw 2<sup>nd</sup> reading.**
- CARRIED**

Councilor J. Lachance mentioned to council that LSCFN should provide a Heritage Land review assessment to council before 3<sup>rd</sup> reading.

**NEW AND UNFINISHED BUSINESS**

**9.1 Transferring Municipal Streets & Roadways from YG Highways to VoC**

CAO M. Cybulski informed council about transfer of streets to VoC. The CMG funding will increase immensely, and we will have a higher budget to maintain roads and driveways.

- 23-17-05 MS Councillors D. Hansen/ K. Unterschute motioned to transfer Municipal Streets and Roadways from YG Highways to the Village of Carmacks.**
- CARRIED**

**9.2. Audit Extension Resolution and Letter**

CAO M. Cybulski drafted a letter of Audit extension to Minister Streicker and council approved and signed letter.

- 23-17-06 MS Councillors J. Lachance/ K. Unterschute motioned to approve the letter of Audit extension.**
- CARRIED**

**QUESTION PERIOD**

No questions from the public.

**IN-CAMERA**

Motion to move into Closed Meeting in accordance with the Yukon Municipal Act, Section 213 (3) (a) if in the case of a council, the council decides during the meeting to meet as a council committee to discuss a matter;

- 23-17-08 M/S Councillors D. Hansen/ H. Belanger motioned to go in-camera at 9:20PM.**
- 23-17-09 M/S Councillor D. Hansen motioned to go out of in-camera at 9:32PM.**
- 23-17-10 M/S Councillors D. Hansen motioned to go back to in-camera at 9:33PM.**
- 23-17-11 M/S Councillors J. Lachance motioned to go out of in-camera at 10:12PM.**

**ADJOURNMENT**

- 23-17-12 M/S Councillor J. Lachance motioned to adjourn the meeting at 10:12PM.**

Mayor L. Bodie adjourned the meeting at 10:12PM.

---

Mayor Lee Bodie

---

CAO Matthew Cybulski



# *Little Salmon Carmacks First Nation*

Together today for our children tomorrow.

---

July 11, 2023

Matthew Cybulski  
Village of Carmacks C.A.O  
143 River Drive  
Box 113  
Carmacks, YT, Y0B-1C0

**RE: Rezoning Lot 1092**

Dear Matthew,

Thank you for taking the time to meet with us regarding the Cultural Center project, the project started many years ago, much work has been completed since then including consultation with the community and LS/CFN regarding the program that will be delivered in the facility, what tenants will be part of the facility, design and where the building should be located for example.

The project site is in Lot 1092, please see the attached drawing. This site was chosen by the community, it is near the existing interpretive center. It can be seen by the highway and is close to the river, which are both important factors. LS/CFN has completed site assessments, topographical surveys and studied the site to ensure that it can receive a septic field and will soon undertake work to build a well on site, a YESAA permit application is in progress. During our investigation and review of the site we noticed that the site is zoned as Parkland and that it will need to be rezoned by Carmacks for the cultural center use.

At its heart the cultural center's goal is to protect, preserve, revitalize, and celebrate LS/CFN Northern Tutchone culture, heritage, and language in addition to this important benefit of the project the centre will attract travelers on the Klondike highway to stay longer in Carmacks. It will also provide local jobs during construction and once it is built through staffing the centre. In

---

**Caring, Sharing, Respect and Teaching**

Post Office Box 135, 52 Njnrò, Carmacks, YT, Y0B 1C0  
Phone (867)863-5576 Fax (867)863-5710

our call we discussed leasing space within the facility to house the Village of Carmacks Visitor's Information Center, the synergy between the Cultural Center and the Visitor Information Centre is strong and we agreed combining the two is a perfect fit. The Cultural Centre is also a space for people to learn, in addition to providing space for the Village of Carmacks, we will be providing space for Yukon University to hold classes and it's administrative offices.

Please consider this as our request to rezone Lot 1092. We will follow with a development and building permit as the project progresses.

Sincerely,

A handwritten signature in black ink, appearing to read "Blanchard". The signature is fluid and cursive, with the first letter being a large, stylized 'B'.

Toni Blanchard,  
Heritage Manager



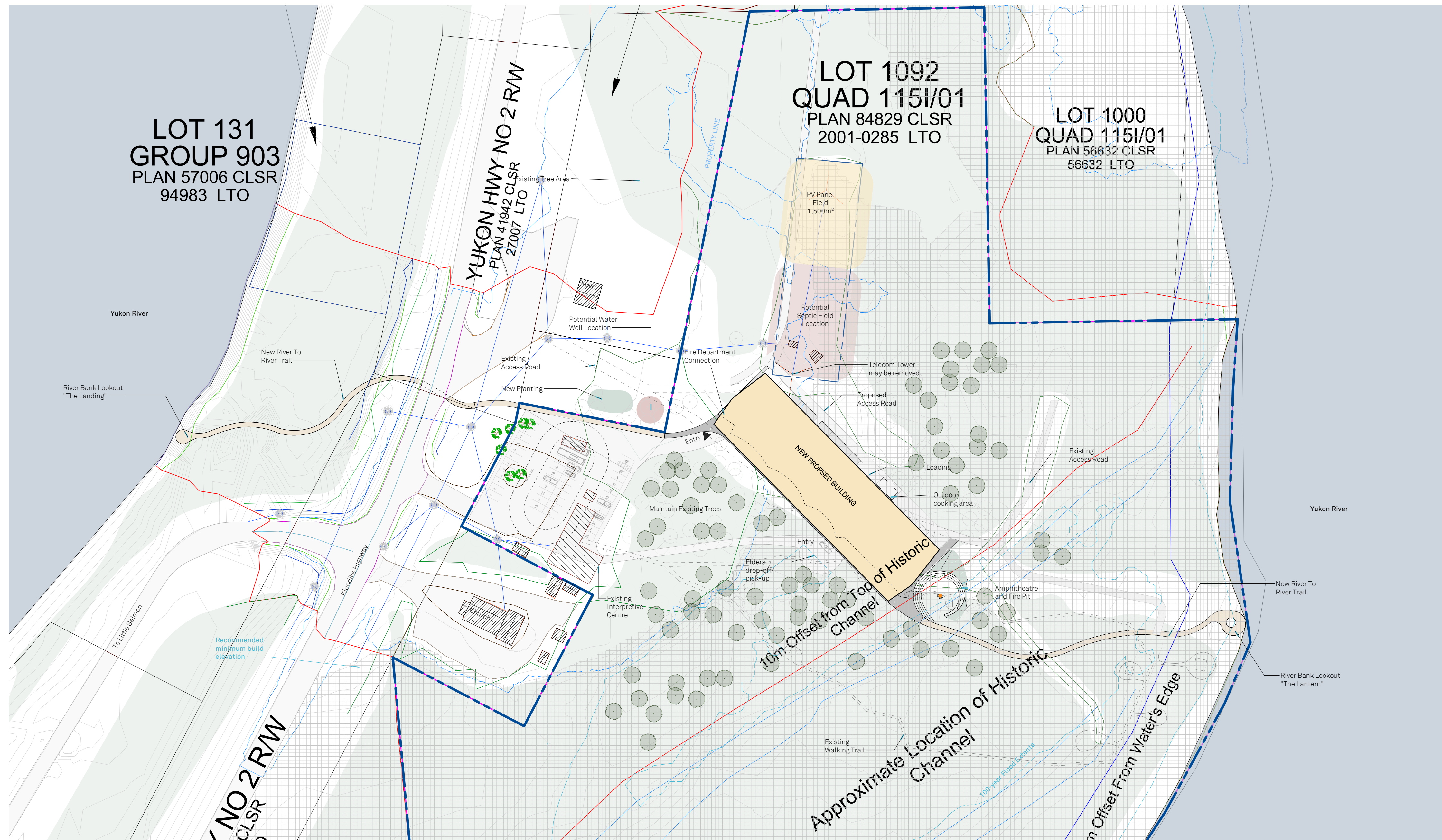

1 Site Plan - Proposed  
 A1.02 1:1000

DATE	REV	DESCRIPTION
------	-----	-------------

**LSCFN CULTURAL CENTRE**  
 Little Salmon Carmacks  
 First Nation  
 HS0072

Site Location Plan  
**A1.02**



**Proposal for**

**Carmacks Arena**

**CSA**  
**(Customer Support Agreement)**  
**Renewal 2023-24**

**Prepared For:**

Matthew Cybulski  
131 River Dr  
Carmacks, YTY0B 1C0  
cao@carmacks.ca

**Prepared By:**

Marlin Gogowich  
mgogowich@toromont.com

August 30, 2023

**TOROMONT**



CIMCO is pleased to present a Customer Support Agreement (CSA) between CIMCO Refrigeration and Carmacks Arena located on 131 River Dr, in Carmacks, YT.

## Standard Customer Support Agreement

Each inspection covers a comprehensive analysis of all aspects of the following:

- Refrigeration Controls
- Refrigerant Levels
- Compression system
- Electrical System
- Condenser operation

At the conclusion of each inspection period, all data is documented on our inspection sheets and a duplicate copy can be provided for your files. The recommendations for repair or replacement will actually be listed on the inspection report and discussed with the Maintenance Manager. Suggested repairs will not be started until notification of approval from your Maintenance Department manager or CAO.

The following services are suggested for your systems. Inspections would be based on two (2) per Year. Inspections include;

(1) Start up / (1) Shutdown, that consist of:

- Proper Startup and Shutdown Procedures
- Complete plant checks at all (2) inspections
- Record Operating Specifics (Pressures, Temperatures, Amperage's, Levels, etc.)
- Visual Inspection of Compression & Condenser Operations
- (1) Cold glycol system Analysis, (1) Warm floor glycol Analysis, (1) Heat Reclaim Glycol loop Analysis
- (2) Compressor Oil Analysis per year (1 on each visit to site)
- (1) Yearly Leak Detection system Calibrations as per the CSA B52 Codes
- (3) Hrs. per year for DDC Inspection/Troubleshooting (via Remote access)
- Recommendations for Preventative Maintenance
- Includes for Shared Travel Expenses (Flights, Travel labour, Lodging and LOA). We will try and coordinate our visits on a service run to the 6 Yukon communities to help reduce travel expenses. Pricing is based on all 6 Yukon communities to try and schedule the visits for the same time frame, to reduce the extra Air Fare. All Shared travel is based from Whitehorse to the communities. **Dedicated trips, if requested or required, will incur additional charges for flights and travel time from Edmonton.**

We anticipate each plant inspection to require 6-8 hrs. Labour.

## Customer Commitment

- Notify CIMCO of unusual operating conditions
- Permit CIMCO staff to use your common building maintenance tools such as ladders
- Provide access to equipment when required,
- Permit only CIMCO personnel to work on specified equipment

## CIMCO CSA Commitment

CIMCO is committed to providing the following additional services as part of this Customer Support Agreement

### Certified and qualified planned inspections benefits:

- Provide access to CIMCO mechanic to clearly identify and educate on system and component issues.
- Preferential and priority service.
- Discounted Parts and Services
- On-staff Professional Engineering.
- Dedicated technical Account Manager

- Asset planning assistance
  - Provide budgeting and scheduling major equipment repairs and/or replacement.
- Protect equipment warranties.
- Maximize equipment reliability.
- Maximize plant safety.
- Detailed service and custom inspection reports for your records.
- CIMCO Emergency Service available 24/7 between inspections.
  - 24/7 On- Call response is available with a maximum 30 minute response via telephone

## Major System Components

- CO2 Compressors
- Plate and Frame Evaporator
- Air Cooled Gas Cooler/Condenser
- All Pumps for the system fluid circuits
- CIMCO DDC System
- Motor Control Panel c/w all motor contractors, fuses, overloads, timer delays, switches
- Safety pressure/electric controls, Pressure gauges
- Control valves, Safety Relief Valves, Isolation Valves

## Scope of Work Included in CSA

CIMCO will offer the following services as part of the Customer Support Agreement

### Compressors

- Inspect compressor shaft seal.
- Check operating pressures and temperatures.
- Inspect compressor unloader mechanism.
- Check compressor motor voltage and current.
- For compressor oil: Provide (2) Oil Sample analysis per year (oil changes if needed are extra)

### Condensers / Fluid Cooler

- Inspect condenser fan(s), eliminators, Wetting Pads and lube as applicable
- Inspect heat transfer section.
- Inspect unit during operation for unusual noise or vibration.
- Check fan motor voltage and current.
- Inspect fan motors and/or bearings.
- Check all condenser interlocks and controls

### Pumps and Motors

- Inspect housing.
- Inspect mechanical seal.
- Lubricate if required.
- Check pump and motor alignment.

### Valves

- Check the operation of all valves related to the refrigeration plant Safety Valves.
- All safety relief valves must be replaced in accordance with the B52 Regulations.
- All safety relief valves must be certified for use with ammonia refrigeration systems.

### Chillers / Surge Drum / Heat Exchangers

- Inspect overall condition of unit.
- Inspect all piping connections and supporting structures.
- Check operation of all safety devices and valves.
- Check for leaks, damaged insulation. (Inspect insulation. As Per **B52 8.4.2(h).**)

- Check all valves for correct operation.
- Ensure all aspects are synchronized with set points and functioning properly.
- Ensure correct refrigerant level.
- Confirm measurements of plate packs between endplates, compare with nameplate info.

#### Piping

- Visual inspection of all connected system piping. As Per **B52 8.4.2(h)**.
- Check for vibration, corrosion, and/or physical damage.
- Check relief vent lines for blockages and condition.
- Check insulation for cracks, missing pieces etc. As Per **B528.4.2(h)**. - *(Repair or replace if required – extra)*

#### Leak Inspection

- Check for ammonia leaks as per **B52 8.4.2(i)**.
- Periodic inspection for leaks if there is evidence of a leak, system operating conditions indicate a loss, or ammonia detection system is activated.

#### Refrigerant

- Verify the volume of refrigerant in the system.

#### Brine / Glycol

- Take cold brine & warm glycol sample once per year and send for lab analysis.
  - Provide additional analysis if requested. (extra)
- Maintain correct levels for:
  - Conductivity, pH, Phosphorate, Calcium chloride strength, Chromium, Corrosion inhibitors
- Take corrective actions if required. (Repairs if required – extra)

#### Plant Safeties and Limits

- Annual testing of Ammonia Plant safeties and limits **B52 8.4.2(c),(d)**.
- Test each safety and limit switch. Including High and low pressure switches, oil pressure switches high level cut-outs, E-Stops, and overloads.
- Calibrate safeties if required.
- Verify system shut-down is activated by safeties and limits.
- Take corrective actions if required. *(Repairs if required – extra)*

#### Refrigerant Detection System (as applicable)

- Annual testing of Refrigerant detection system outlined in **B52 8.4.2(e)**
- Test each sensor with appropriate concentration of calibration gas. Calibrate sensor as required.
- Test audible and visual alarms are activated.

#### Motor Control Center /Panel (MCC /P) and DDC System

- Inspect annually for damage to any connections, breakers, switches etc. As Per **B52 8.4.2(g)**.
- Look for evidence of excessive temperatures.
- Look for damage to wires and connectors.
- Tighten electrical connections.

#### Plant room ventilation fans (as applicable)

- Verify ventilation is activated with detection system.
- Take corrective actions if required. *(Repairs if required – extra)*
- Check all belts, motors filters and dampers. *(Replace or repair if required – extra)*
- Verify capacity of air moved complies with all applicable laws, regulations and codes.

The above scope of work complies with **B52 code requirements** for maintenance and is typical for arenas.

If any items need to be repaired or replaced, they will be noted on the service report as well as a follow up from either our service manager or account manager. CIMCO does not perform any work without prior authorization from the customer.

## CSA Terms

The proposed agreement will **start on September 1, 2023 and will continue to August 31, 2024 ("Initial Term")**. Each subsequent Term shall automatically renew for a period of the same length as the Initial Term unless either party gives the other written notice of termination of at least thirty (30) days prior to expiration of the current term.

### The annual cost for this agreement is \$6,995.00 (All Taxes Extra)

**This Agreement includes a preferred customer loyalty 10% discount on the current labour rates, with a 10% discount on parts for the duration of the agreement.**

- **To be applied to all work conducted on Time & Materials basis during the contact term.**

Price is in Canadian funds and valid for 30 days

Standard Terms & Conditions Apply

The above amount will be billed on a yearly basis in advance at the indicated rate, until the contract end date.

This CSA can be cancelled by providing written notice by either party 60 days prior to the then current term.

\*\*This CSA may have Renewal rate increases once per year, based on standard inflation and/or union wage increases.

## Exclusions

- Emergency calls or additional trips for work outside the CSA inspection trips will be charged as extra
- Provide clear and unobstructed access to work area is the responsibility of the owner / others.
- All work required outside of CIMCO regular working hours requested or required by owner.
  - Labour is based on regular working hours 8am – 4:30pm, Monday – Friday. Outside these hours additional charges will apply
- Additional refrigerant charge, top up of oil or other fluids.
- It is understood that CIMCO will use professional care in performing the above services and shall not be liable for failure to other components associated with this customer support agreement.
- Disposal or abatement of existing refrigerant, water, asbestos, equipment, material, or any other substance not mentioned including any environmental testing or verification that may be required to complete scope of work.
- Any material or work not clearly stated within the scope of work will be the responsibility of the owner.

## Agreement

The information contained in this proposal constitutes the terms between CIMCO Refrigeration Inc., and the client Carmacks Arena.

All prices agreed upon will be honored by both parties. Continued services after that time will require a new agreement.

**Billing and Payment Terms.** CIMCO will invoice Carmacks Arena as per the terms of this agreement, and Carmacks Arena will pay each such invoice within thirty (30) days after the date thereof. Invoices not paid within such thirty (30) day period will accumulate interest as per the terms and conditions of this agreement.

**Authorized Signature:** The undersigned agrees to the terms of this contract on behalf of the organization or business

*Matthew Cybulski*

Signature of Client: \_\_\_\_\_ Date: 09 / 01 / 2023

Purchase Order :



## TERMS AND CONDITIONS

SUBJECT TO WRITTEN APPROVAL BY A DULY AUTHORISED OFFICER OF CIMCO REFRIGERATION (THE "VENDOR"), THIS QUOTATION, IF ACCEPTED IN WRITING BY THE PURCHASER, SHALL CONSTITUTE A BINDING CONDITIONAL CONTRACT OF SALE AS OF THE DATE OF THE PURCHASER'S ACCEPTANCE OR AS OF THE DATE OF THE VENDOR'S APPROVAL, WHICHEVER IS LATER. THIS QUOTATION IS INVALID IF NOT ACCEPTED BY THE PURCHASER WITHIN THIRTY DAYS OF THE DATE OF QUOTATION.

### 1. TITLE

(a) The title and ownership to and in the materials, equipment and other goods sold here under (the "goods") shall remain with the Vendor until payment in full of the Contract Price and any additional amounts payable to the Vendor pursuant to sections 2 and 10 of these Terms and Conditions. The Vendor hereby reserves, and the Purchaser hereby grants to the Vendor, a security interest in and to the goods, and the proceeds thereof, to secure the said payment and all of the other obligations of the Purchaser. At the option of the Vendor, the Purchaser will join with the Vendor in executing, in a form satisfactory to the Vendor, one or more financing statements or similar instruments pursuant to any applicable personal property security legislation. The Purchaser hereby authorizes the Vendor to file one or more such statements or instruments signed by the Vendor alone as the secured party. If the goods are to become affixed to real property, the Purchaser represents that a true and correct description of such real property and that the name of the registered owner thereof are as indicated on Page 1 of this Quotation/Contract.

(b) In the event of default by the Purchaser under the terms of payment of this contract, the full amount of the Contract Price, less any payments previously made, shall become due and payable, and the Vendor or its agent shall have the right to enter upon the premises and remove the goods, and to dispose of them as the Vendor may determine. If the proceeds from such disposal, less any related expenses, including but not limited to costs of seizure, removal and sale, and legal costs (including reasonable attorneys' fees and expenses) connected therewith (the "net proceeds"), are not sufficient to cover the amount in default, the Purchaser shall be liable to the Vendor for such deficiency. If the net proceeds exceed the amount in default such excess shall be returned to the Purchaser, and the Vendor shall not be liable further whether in respect of completion, performance, warranty or other contract terms.

(c) The Purchaser hereby waives all rights and claims against the Vendor in the event that the circumstances provided for in section 1 (b) arise, except for the express right of recovery of excess net proceeds as provided in that section.

(d) The Purchaser hereby waives the provisions of any Conditional Sales Act or other applicable legislation which limits the Vendor's rights to seize the security provided for herein, and to sue for any deficiency. The Purchaser expressly confers upon the Vendor the rights to seize and sell the goods and to recover from the Purchaser, by action on the covenant, the principal, interest and other moneys from time to time owing under this contract.

(e) Until the Contract Price has been paid in full, the Purchaser will not sell or agree to sell, or mortgage, charge or dispose of, or intentionally injure the goods or remove them from the place of initial installation.

### 2. PRICE ADJUSTMENTS

(a) The Purchaser shall pay all taxes, duties, levies and other charges assessed against or in respect of the goods, except those taxes, duties, levies and other charges expressly included in the Contract Price.

(b) If any taxes, duties, levies, or other charges shown to be included in the Contract Price are increased subsequent to the Date of Quotation, and increase the Vendor's costs here under, such increase shall be paid by the Purchaser to the Vendor.

(c) The Contract Price quoted herein is based on prices, costs and conditions prevailing at the Date of Quotation. Unless otherwise specified, if the estimated delivery and / or installation date is more than six months from the date of the contract, and if prior to shipment or installation there is an increase in the Vendor's costs due to increases in labor rates, cost of materials, suppliers' prices, foreign exchange, storage charges, or freight rates, such increase shall be paid to the Vendor by the Purchaser.

(d) If delivery or installation is delayed by the Purchaser, or by anyone under the Purchaser's control, for more than two months after the time estimated, any increase in those categories of the Vendor's costs listed in section 2(c) shall be paid to the Vendor by the Purchaser.

(e) All payments by the Purchaser to the Vendor under section 2 shall be in addition to the Contract Price and shall be paid at the time the final payment under the contract is due.

### 3. LIABILITY

The Vendor shall not be liable for any losses, injuries, expenses or damages, whether direct, indirect, special, incidental, consequential or punitive, arising out of the goods, or the installation, operation, or failure of operation of the goods or related systems even if caused by the Vendor's negligence.

### 4. DELIVERY AND INSTALLATION

Delivery and installation times and dates are approximate and are subject to extension for delays caused by fire, strike, lockout, labor dispute, civil or military authority, riot, embargo, car shortage, wrecks or delays in transportation, Acts of God, late delivery or non-delivery by the Vendor's suppliers, changes in the scope of the work as provided in section 9 of these Terms and Conditions, or other causes beyond the reasonable control of the Vendor, and the Vendor shall not be liable for any losses or damages resulting from any such causes. Acceptance of the work shall be a waiver by the Purchaser of all claims for damages for delay from any cause whatsoever.

### 5. RESPONSIBILITY AND INSURANCE

(a) In respect of goods sold F.O.B. point of origin, the Vendor shall deliver the goods in good condition to a common carrier or to the Purchaser at the Vendor's shipping point, and thereupon all risks of loss or damage thereto shall pass to the Purchaser.

(b) In respect of goods sold F.O.B. job site or sold with installation, all risks of loss or damage shall pass to the Purchaser upon receipt of the goods at the job site or at the Purchaser's designated delivery point.

(c) The Purchaser shall insure the goods against loss or damage from fire, theft, malicious damage or other causes as and from the time the Purchaser becomes responsible for the goods pursuant to sections 4(a) and 4(b) of these Terms and Conditions. The face value of the insurance policy shall be in an amount not less than the Contract Price. Any loss under such insurance policy shall be made payable to the Vendor as its interest may appear until the Contract Price shall be paid in full.

(d) Upon the request of the Vendor, the Purchaser shall provide an insurance certificate as evidence of the compliance with section 4(c) of these Terms and Conditions.

### 6. COST ESCALATION

Contractor and Owner acknowledge and agree that at the time of execution of this project agreement, it is unknown whether prior estimates for performance of the Work will be impacted by further development of the design, changed market conditions, availability of labor, equipment and/or materials or other conditions which materially differ from those existing at the time prior estimates were received. Contractor agrees to make diligent and best efforts to mitigate any cost or schedule impacts arising out of these changed conditions. However, subject to such mitigation obligations of the Contractor, Owner agrees that Contractor shall be entitled to an equitable adjustment of the Contract Sum and/or, if applicable, the Contract Time due to the following non-exhaustive list of possible events or circumstances: (1) a Subcontractor will not honor its prior estimate, (2) commodity price escalation and/or commodity delivery date impacts due to the length of time between a Subcontractor providing its estimate and subcontract award, (3) general conditions cost impacts due to anticipated completion dates at the time of Subcontractor's estimate differing from completion dates anticipated at time subcontract award, (4) commodity price escalation and/or delivery date impacts due to Subcontractor inability to obtain firm pricing or delivery date commitments from any supplier at or near time of subcontract award; or (5) cost of on-site or off-site material storage capacity to enable early receipt of certain materials when early procurement of such materials can be achieved for avoidance of price escalation or to secure availability so that the project schedule can be maintained.

### 7. TERMS OF PAYMENT

(a) Unless otherwise stated within this documents payment will occur quarterly in advance.

(b) All claims for shortages or damage, or any rejection of the goods described on the front of this invoice (the "Goods") for non-conformity, must be made in writing within 5 days of receipt of the Goods. All Goods shipped at buyer's risk. No unauthorized returns. Minimum 15% handling charge on returned Goods.

(c) Timely payment according to the terms of this Quotation/Contract is of the essence of the contract.

(d) Payment shall be made in the specified currency.

## 8. WARRANTY

UNLESS OTHERWISE SPECIFIED IN THIS QUOTATION/CONTRACT, THE VENDOR WARRANTS THE GOODS AND INSTALLATION SOLD HERE UNDER AGAINST ORIGINAL DEFECTS IN MANUFACTURE AND WORKMANSHIP FOR A PERIOD OF ninety (90) days FROM COMPLETION AS DEFINED IN SECTION 9 OF THESE TERMS AND CONDITIONS. THIS WARRANTY IS IN LIEU OF ALL OTHER WARRANTIES, STATUTORY OR OTHERWISE, EXPRESS OR IMPLIED, INCLUDING FOR MERCHANT ABILITY OR FITNESS FOR A PARTICULAR PURPOSE. THE TERMS OF THE VENDOR'S WARRANTY ARE AS FOLLOWS:

- (a) In respect of goods sold without installation, the Vendor's sole liability shall be to repair or replace, at the Vendor's option, F.O.B. point of manufacture, any defective goods or parts thereof.
- (b) In respect of goods sold with installation, the Vendor's sole liability shall be to repair or replace, at the Vendor's option, any defective goods or parts thereof or any defective workmanship. The Vendor shall be responsible for all of its costs in connection therewith other than the out-of-pocket expenses incurred by the Vendor's employees and agents travelling from the Vendor's nearest place of business to the job site and charges for labor performed after normal working hours at the request of the Purchaser, which latter expenses and charges shall be for the account of the Purchaser.
- (c) The Vendor warrants goods not of the Vendor's manufacture only to the extent to which the Vendor is able to enforce a claim for liability against the manufacturer thereof.
- (d) The Purchaser shall promptly give written notice to the Vendor after the discovery of an apparent defect.
- (e) As a condition precedent to any liability by the Vendor here under, the Purchaser shall use, operate and maintain the goods and related systems in a careful, prudent, and reasonable manner, and in conformity with the Vendor's and / or the manufacturers' instructions.
- (f) the foregoing constitutes the purchaser's exclusive remedy and the vendor's sole liability arising out of the design, manufacture, sale, installation, or use of the goods.
- (g) This warranty shall be void if the Purchaser is in default under the terms of payment of this contract.

## 9. CHANGE IN SCOPE OF WORK

If the Purchaser requests a change in the scope of the work under this Quotation/Contract, the Vendor will submit a Contract Revision to the Purchaser which shall set forth the proposed changes in the work, and if the proposed changes result in an addition to or a deduction from the Contract Price, the Contract Revision shall set forth the amount of such addition or deduction. A Contract Revision shall not be binding or enforceable unless accepted in writing by the Purchaser and approved in writing by a duly authorized officer of the Vendor. Upon such acceptance and approval, the Contract Revision shall become part of the contract and, except when in consistent therewith, shall be subject to all its provisions.

## 10. COMPLETION AND ACCEPTANCE OF WORK

- (a) In respect of goods sold without installation, "Completion" shall be deemed to occur when risk of loss of the goods passes to the Purchaser in accordance with section 4 of these Terms and Conditions.
- (b) In respect of goods sold with installation, and unless otherwise defined in this Quotation/Contract, "Completion" shall be deemed to occur when any one of the following events takes place:
  - i. The Purchaser signs an acceptance certificate;
  - ii. The Vendor has installed and, where applicable, successfully tested the installation;
  - iii. The Purchaser commences regular use of the goods correlated systems;
  - iv. An independent expert, mutually acceptable to the Purchaser and the Vendor, certifies that the work has been completed.
- (v) The Vendor shall have the right to subcontract all or any part of the installation work to others;
- (vi) The Vendor shall have the right to start installation immediately after delivery of the Goods to the installation site, and if the start of installation work is delayed beyond 30 days after such delivery, the full amount of the price and all charges hereunder, less any portion thereof separately specified as installation charges, shall at the option of the Vendor become immediately due and payable;
- (vii) Unless requested by the Purchaser and agreed to by the Vendor, no Saturday, Sunday, holiday or other overtime labor will be provided in connection with installation work, and if provided, all premium wage costs incurred shall be added to the invoice as a separate charge to be paid by the the Purchaser
- (c) Nothing in subsections (a) or (b) shall relieve the Vendor from its obligation to honor the warranty provisions contained herein.
- (d) The occurrence of any one of the events described in section 9(b)(i), (iii) and (iv) shall constitute acceptance of the work.

## 11. BONDS

Performance bonds and material and labor payment bonds will be provided by the Vendor upon request. Unless the Contract Price expressly includes the cost of such bonds, the Purchaser, in addition to the Contract Price, shall pay the cost of such bonds to the Vendor at the time of the receipt thereof by the Purchaser.

## 12. MISCELLANEOUS

- (a) This Quotation and any resulting contract shall be governed, enforced and construed in accordance with the laws of the Province/State of YT without regard to that province's/state's rules governing conflict of laws.
- (b) All rights and remedies of the Vendor under this contract and under applicable law shall be cumulative and may be exercised successively or concurrently, in any order, and on more than one occasion. The election by Vendor to exercise one remedy shall not preclude it from thereafter exercising one or more other remedies.
- (c) The Purchaser agrees to pay, in addition to the other amounts payable to Vendor under the contract, all costs and expenses, including reasonable attorneys' fees, incurred by the Vendor in enforcing this contract, exercising its rights here under or collecting or attempting to collect all amounts due the Vendor here under following default by the Purchaser in the payment or performance of its obligations here under, including those incurred in connection with any bankruptcy, insolvency, liquidation, reorganization or similar proceeding involving the Purchaser.
- (d) Any assignment or attempted assignment of this contract, in whole or in part, without the prior written consent of the Vendor shall be void. The Vendor may assign any of its rights, liabilities or obligations arising out of this contract without prior notice to the Purchaser and without the Purchaser's written consent except that the Vendor may not assign its warranty obligations without the Purchaser's written consent.
- (e) If any provision of this contract is unenforceable, such unenforceability shall not affect the remaining terms, which shall be enforced, if the same can be done, without regard to the unenforceable provision.
- (f) The headings to the paragraphs of this contract are provided for ease of reference only and shall not be construed to vary or limit the terms thereof.

**THIS QUOTATION/CONTRACT CONTAINS THE COMPLETE AGREEMENT BETWEEN THE PURCHASER AND THE VENDOR, AND SUPERSEDES ALL PRIOR ORAL OR WRITTEN REPRESENTATIONS, PROMISES, AGREEMENTS OR UNDERSTANDINGS WITH RESPECT TO THE SUBJECT MATTER HEREOF.NO REPRESENTATION, PROMISE, AGREEMENT OR UNDERSTANDING ENTERED INTO OR MADE SUBSEQUENT TO THE DATE OF THE CONTRACT WHICH VARIES OR MODIFIES THE PROVISIONS OF THIS CONTRACT SHALL BE BINDING ON THE VENDOR UNLESS CONVEYED IN WRITING AND EXECUTED BY THE DULY AUTHORISED OFFICER OF THE VENDOR EXECUTING THIS QUOTATION/CONTRACT.**



# Signature Certificate

Reference number: XES4D-YRQ3G-UWJJB-ZA5BF

## Signer

**Matthew Cybulski**  
Email: cao@carmacks.ca

Sent:  
Viewed:  
Signed:

## Timestamp

30 Aug 2023 23:04:14 UTC  
30 Aug 2023 23:24:03 UTC  
13 Sep 2023 17:21:32 UTC

## Signature



## Recipient Verification:

✓ Email verified

30 Aug 2023 23:24:03 UTC

IP address: 170.203.222.1  
Location: Calgary, Canada

Document completed by all parties on:  
13 Sep 2023 17:21:32 UTC

Page 1 of 1



**Signed with PandaDoc**

PandaDoc is a document workflow and certified eSignature solution trusted by 40,000+ companies worldwide.







## Village of Carmacks

P.O.Box 113  
Carmacks, YT Y0B 1C0

To: Mayor & Council

Date: September 19, 2023

From: Matthew Cybulski, Chief Administrative Officer, Village of Carmacks

Re: CAO Debrief (September 5, 2023 to September 19, 2023)

---

Hello Mayor & Council,

Major updates and minor debriefing of municipal service developments and administrative activities:

### 1. Firehall Updates

- Facility Grand Opening hosted on September 16<sup>th</sup>, 2023
- 114 Raffle Tickets entered throughout the festivities and 72 Recreation Logo Survey's completed.
- Custodial Contractor progress meeting planned for late September (Firehall & CRC)
- Door deficiencies are being work ordered through Clark Builders & YG-IDB (September 20<sup>th</sup>)

### 2. CMHC HAF Update

- \$4.2 Million submission finalized.
- Finalized draft to be submitted September 25<sup>th</sup>.
- E-permitting system quoted under budget
- Meeting with Non for-Profit partners scheduled for mid October
- High Density Housing Complex – Plan for Tender under development.

### 3. Regional Landfill Update

- Bag Tags designed and ordered (See Appendices for design)
- VoC Landfill Townhall Meeting #2 – Delayed
- Landfill Regionalization Walkthrough (September 18<sup>th</sup>) – Attended by VoC PW GM, CAO, Community Services – Dave Albisser, Greenwood Engineering, Ian – Tintina Engineering

Telephone: (867) 863-6271

Fax: (867)863-6606

Email: [info@carmacks.ca](mailto:info@carmacks.ca)



## Village of Carmacks

P.O.Box 113  
Carmacks, YT Y0B 1C0

- Major logistical delays in sourcing of secondary gate and staff attendant station
- Project will not be tendered until December 2023
- Project completion to be anticipated for July 2024
- Project delay severely impacts the effectivity date of By-Law 291-23 “Landfill Service Rates”
- Infrastructure requirements for Landfill Service Fee implementation will not be active until Mid-2024.
- Discuss VoC sourcing the staff attendant station vs delaying Service Fee timeline.

#### 4. Updates at a Glance

- Tier #2 CDF submitted for 24 Hour Key Fob Access to CRC and CCTV Upgrades (\$46,000)
- VoC Administration, PW GM, and Mayor & Council – Capital Budget Special Meeting – Determine October Date
- Gas Tax Application for Steam/Vac Combo Mack Truck – To Be Submitted September 22nd
- VoC Staffing Wage Scale to be reviewed and proposed increase to be shared for October 17<sup>th</sup> – Council Meeting

#### 5. On the Horizon

- The Premier’s visit scheduled for October 17<sup>th</sup> during regularly scheduled council meeting.
- Minister Mostyn’s Office community tour – September 20<sup>th</sup> @ 7PM.
- Joint Council Meeting potential dates shared with LSCFN – Awaiting reply.

Telephone: (867) 863-6271

Fax: (867)863-6606

Email: [info@carmacks.ca](mailto:info@carmacks.ca)



# GOVERNMENT OF YUKON

DEPARTMENT OF COMMUNITY SERVICES  
INFRASTRUCTURE DEVELOPMENT BRANCH

## VILLAGE OF CARMACKS SANITARY SEWER REPAIRS



KEY PLAN  
NTS



Whitehorse Office  
+1 867 668 2525  
#205 - 133 Industrial Road  
Whitehorse, YT  
Y1A 2V2, CANADA



ISSUED FOR CONSTRUCTION  
AUGUST 2023



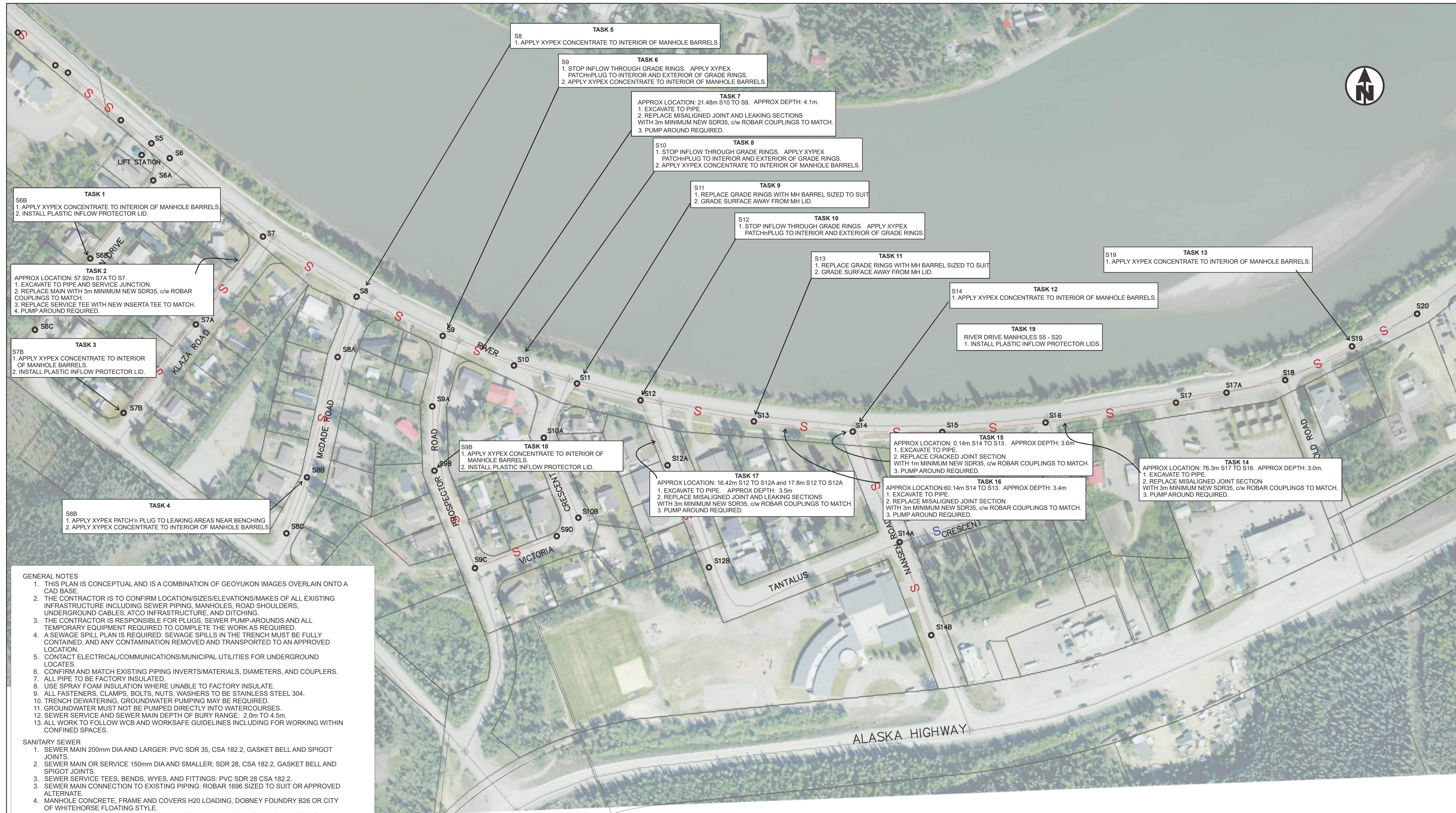

- GENERAL NOTES**
- THIS PLAN IS CONCEPTUAL AND IS A COMBINATION OF GEOYUKON IMAGES OVERLAIN ONTO A CAD BASE.
  - THE CONTRACTOR IS TO CONFIRM LOCATION/SIZES/ELEVATIONS/MAKES OF ALL EXISTING INFRASTRUCTURE INCLUDING SEWER PIPING, MANHOLES, ROAD SHOULDERS, UNDERGROUND CABLES, AT&CO INFRASTRUCTURE, AND DITCHING.
  - THE CONTRACTOR IS RESPONSIBLE FOR PLUGS, SEWER PUMP-AROUNDS AND ALL TEMPORARY EQUIPMENT REQUIRED TO COMPLETE THE WORK AS REQUIRED.
  - A SEWAGE SPILL PLAN IS REQUIRED. SEWAGE SPILLS IN THE TRENCH MUST BE FULLY CONTAINED, AND ANY CONTAMINATION REMOVED AND TRANSPORTED TO AN APPROVED LOCATION.
  - CONTACT ELECTRICAL/COMMUNICATIONS/MUNICIPAL UTILITIES FOR UNDERGROUND LOCATES.
  - CONFIRM AND MATCH EXISTING PIPING INVERTS/MATERIALS, DIAMETERS, AND COUPLERS.
  - ALL PIPE TO BE FACTORY INSULATED.
  - USE SPRAY FOAM INSULATION WHERE UNABLE TO FACTORY INSULATE.
  - ALL FASTENERS, CLAMPS, BOLTS, NUTS, WASHERS TO BE STAINLESS STEEL 304.
  - TRENCH DEWATERING, GROUNDWATER PUMPING MAY BE REQUIRED.
  - GROUNDWATER MUST NOT BE PUMPED DIRECTLY INTO WATERCOURSES.
  - SEWER SERVICE AND SEWER MAIN DEPTH OF BURY RANGE: 2.0m TO 4.5m.
  - ALL WORK TO FOLLOW WCB AND WORKSAFE GUIDELINES INCLUDING FOR WORKING WITHIN CONFINED SPACES.
- SANITARY SEWER**
- SEWER MAIN 200mm DIA AND LARGER: PVC SDR 35, CSA 182.2, GASKET BELL AND SPIGOT JOINTS.
  - SEWER MAIN OR SERVICE 150mm DIA AND SMALLER: SDR 28, CSA 182.2, GASKET BELL AND SPIGOT JOINTS.
  - SEWER SERVICE TEES, BENDS, WYES, AND FITTINGS: PVC SDR 28 CSA 182.2.
  - SEWER MAIN CONNECTION TO EXISTING PIPING: ROBAR 1696 SIZED TO SUIT OR APPROVED ALTERNATE.
  - MANHOLE CONCRETE, FRAME AND COVERS H20 LOADING, DOBNEY FOUNDRY B26 OR CITY OF WHITEHORSE FLOATING STYLE.
  - SERVICE TEE: SDR 28 SANITARY TEE TO MATCH MAIN AND SERVICE PIPE DIAMETERS.
  - PVC SDR 28 SPOOLS AS REQUIRED TO MATCH SERVICE PIPE DIAMETER.
  - MANHOLE BARRELS: TO MATCH EXISTING MH MANUFACTURER BARRELS. H20LOADING TO BE MAINTAINED.
  - APPLY CLOSED-CELL SPRAY FOAM INSULATION TO ALL REPAIR LOCATIONS WHERE NOT FACTORY INSULATED. MINIMUM 75mm THICKNESS.
- CONCRETE WATERPROOFING**
- XYPEX CONCENTRATE OR APPROVED EQUAL. FOLLOW MANUFACTURER'S INSTRUCTIONS.
- CONCRETE LEAK REPAIR**
- XYPEX PATCH 'n PLUG OR APPROVED EQUAL. FOLLOW MANUFACTURER'S INSTRUCTIONS.
- MANHOLE LID INFLOW PROTECTOR**
- POLLARDWATER MANHOLE INFLOW PROTECTOR INSERT. SIZED TO SUIT.

Revision	Amendment	Approved	Revision Date
	ISSUED FOR TENDER	LB	2021/08/01
	RE-ISSUED FOR TENDER	LB	2022/05/27
	RE-ISSUED FOR TENDER	LB	2023/06/28
	ISSUED FOR CONSTRUCTION	LB	2023/08/24



205-133 Industrial Road  
Whitehorse YT  
Y1A 2V2, Canada

Designed	Approved	Approved Date
BM	LB (L BAKELAAR)	2021/JULY/31
Drawn	Scale	Project No.
LB (L BERUBE)	as noted	211-07360-00

Project	
VILLAGE OF CARMACKS SANITARY SEWER REPAIRS	
Sheet	
REPAIR PLAN	
Sheet No.	Revision
1	3



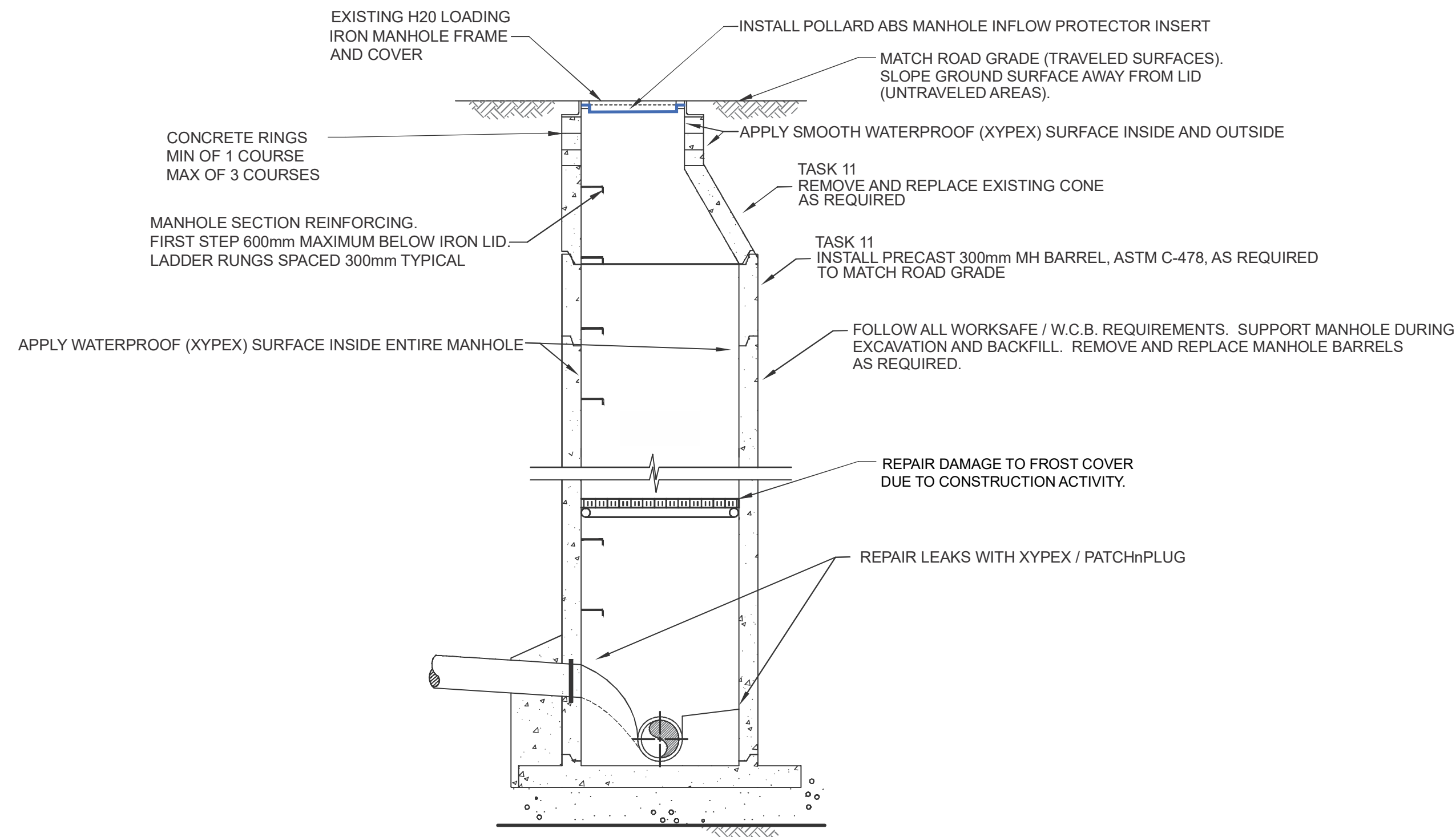

TYPICAL MANHOLE REPAIR DETAIL NTS

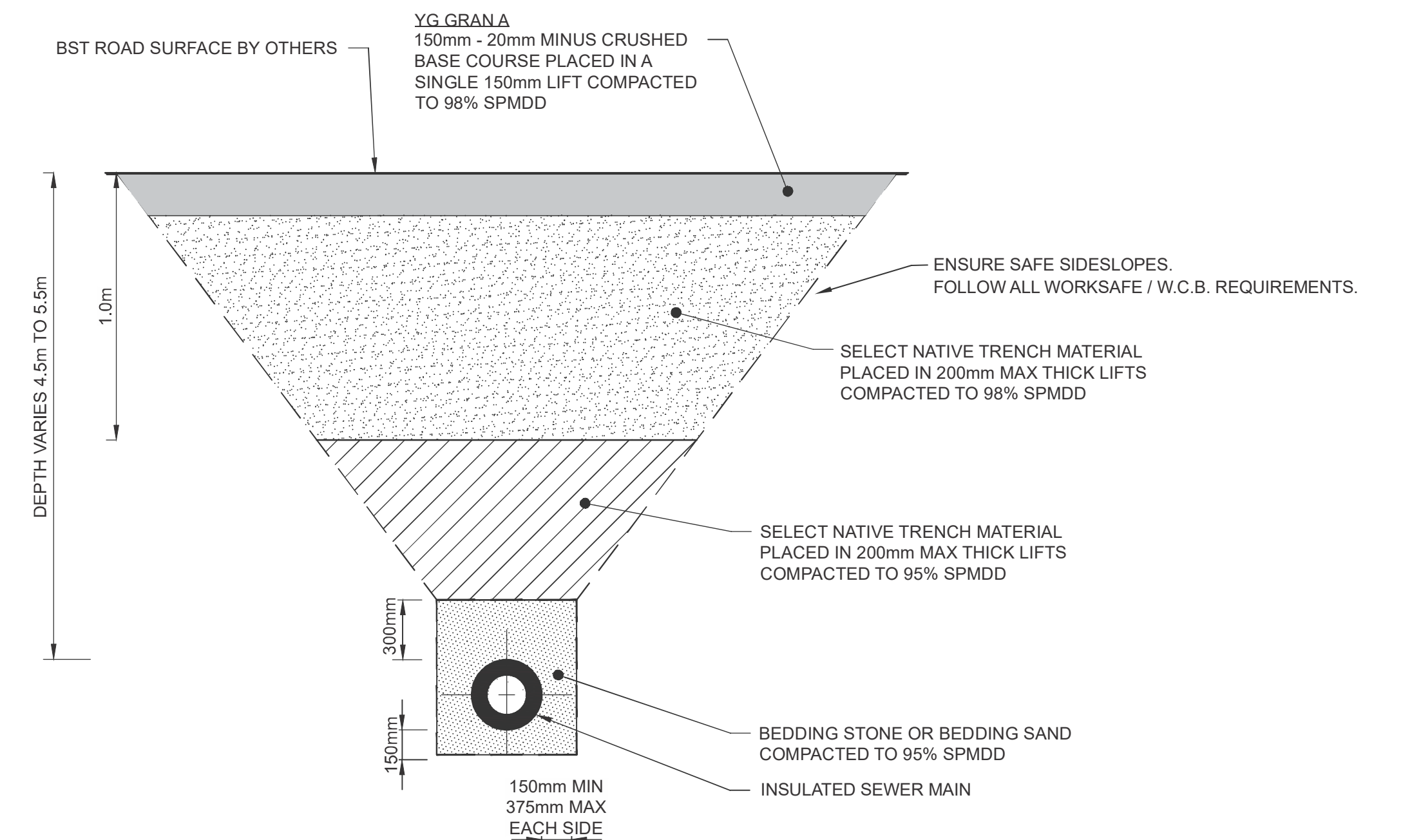

- NOTE:
1. ALL TRENCHES SHALL BE EXCAVATED IN ACCORDANCE WITH W.C.B. REGULATIONS.
  2. UNSHORN TRENCH SHOWN FOR CLARITY.
  3. BEDDING AND COMPACTION REQUIREMENTS TYPICAL FOR ALL PIPE
  4. OVER EXCAVATION AREA TO BACKFILLED WITH 80mm MINUS PIT RUN SUB BASE AND COMPACTED TO 95% SPD.
  5. ALL BACKFILL TO BE PLACED IN MAXIMUM 200mm THICK LIFTS.

TYPICAL TRENCH DETAIL NTS

AGGREGATE GRADATION TABLE

BEDDING SAND		BEDDING STONE	
PARTICLE SIZE (mm)	% PASSING BY MASS	PARTICLE SIZE (mm)	% PASSING BY MASS
10.000	100	25.000	100
5.000	80 - 100	20.000	70 - 100
2.000	55 - 100	12.500	55 - 100
0.630	25 - 65	10.000	30 - 80
0.250	10 - 40	5.000	0 - 40
0.080	2 - 15	2.000	0 - 10

80mm PIT RUN SUB-BASE AGGREGATE		20mm CRUSHED BASECOURSE AGGREGATE	
PARTICLE SIZE (mm)	% PASSING BY MASS	PARTICLE SIZE (mm)	% PASSING BY MASS
80.0	100	20.0	100
25.0	55 - 100	12.5	64 - 100
12.5	42 - 84	5.0	36 - 72
5.0	26 - 65	2.5	18 - 54
1.25	11 - 47	1.25	12 - 42
0.315	3 - 30	0.315	2 - 22
0.080	0 - 8	0.080	3 - 6

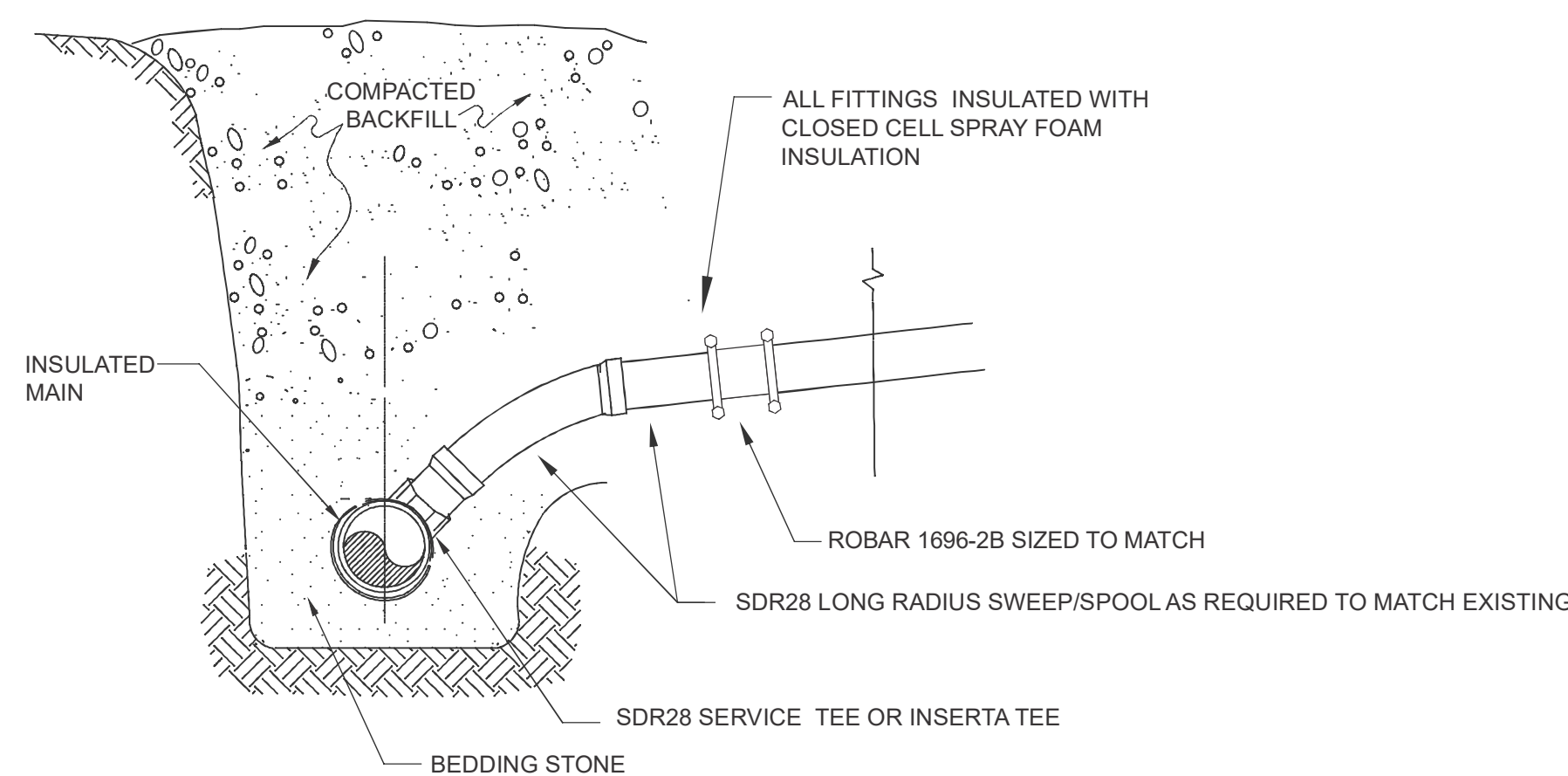

TYPICAL PIPE REPAIR DETAIL NTS

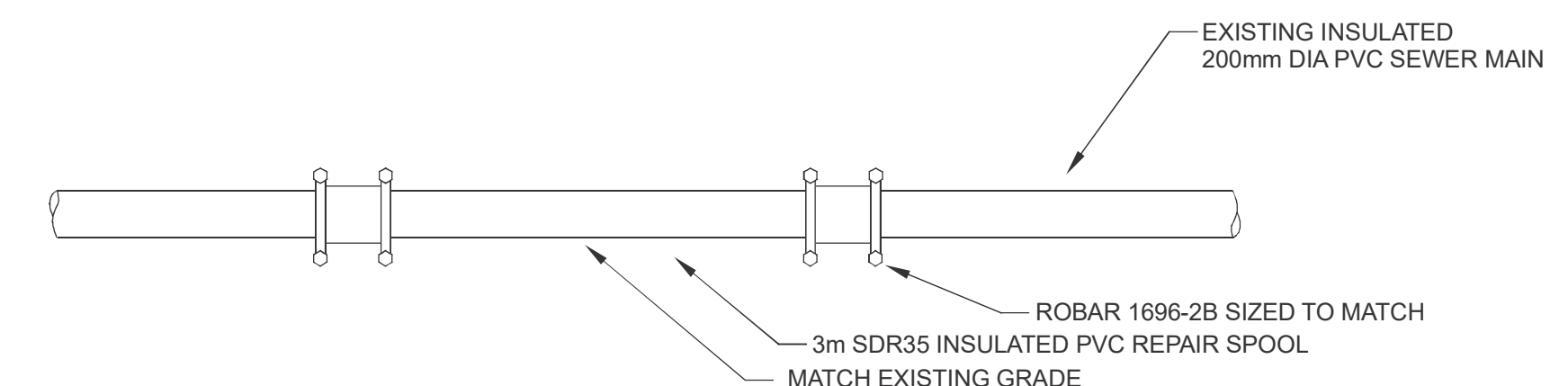

Revision	Amendment	Approved	Revision Date
1	ISSUED FOR TENDER	LB	2021/08/01
2	RE-ISSUED FOR TENDER	LB	2022/05/27
3	RE-ISSUED FOR TENDER	LB	2023/06/28
4	ISSUED FOR CONSTRUCTION	LB	2023/08/24

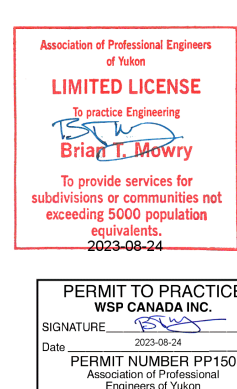

205-133 Industrial Road  
Whitehorse YT  
Y1A 2V2, Canada

Designed	Approved	Approved Date
BM	LB (L BAKELAAR)	2021/JULY/31
Drawn	Scale	Project No.
LB (L BERUBE)	as noted	211-07360-00

Project	
VILLAGE OF CARMACKS SANITARY SEWER REPAIRS	
Sheet	
REPAIR DETAILS	
Sheet No.	Revision
2	n/a